



承 认 书

SPECIFICATION FOR APPROVAL



Commodity 产品:

- ❖ Outline (L×W×H) 外观尺寸: 2.0mm×3.0mm×4.0mm
- ❖ Forward current 顺向电流: ≤30mA
- ❖ Typical viewing angle 50% Iv角度: 175°
- ❖ Emitting color 发光颜色: Yellow 黄光
- ❖ Lens color 胶体颜色: Yellow Diffused 黄色雾面
- ❖ MSL湿敏等级: Level 1 Based on JEDEC J-STD 020
- ❖ RoHS & REACH-compliant 符合 RoHS 和 REACH 要求

This is a preliminary specification intended for design purposes and subject to change without prior notice.

➤ PLEASE PAY ATTENTION TO THE MOISTURE-ABSORBING PROBLEM, AND REFER TO THE OPERATING INSTRUCTIONS FOR THE DETAILS
请注意产品的防潮，储存及使用请参考LED使用说明。

产品型号 Model No	H-23HDY11A0H13-B	
客户名称 Customer Name		
客户确认 Check By	客户核准并签章 Authorized By	客户产品要求范围 Application Range

◆承认盖章后请寄回承认书一份
Please return the book that stamp admitted

☆☆☆☆☆☆☆☆☆☆☆☆☆☆☆☆☆☆☆☆☆☆☆☆☆☆☆☆☆☆☆☆☆☆☆☆☆☆☆☆☆☆☆☆☆☆

深圳市弘亮光电有限公司
 地址: 廣東省深圳市寶安區沙井鎮芙蓉工業區西區B入口
 Add: West Area A entrance Furong industrial ShajingTown Bao'an dist Shenzhen China.
 TEL: 86-755-81760601 FAX: 86-755-81760602
 Http:// www.hongbright.com E-mail: kai@hongbright.com



Table of Contents 目录

❖ Table of contents	
目录 02
❖ Outline Dimensions	
外观尺寸图纸 03
❖ Maximum Rating	
最大额定电性参数 04
❖ Electronic-optical Characteristics	
LED 光电参数数据表 04
❖ Electronic-optical Graph	
光电参数关系图表 05
❖ LED Usage and Handling Instructions	
LED 使用说明 06
❖ Reliability test	
可靠性测试标准 12



❖ Outline Dimensions 外观尺寸

Item 项目	Materials 材质
Resin(Mold)胶体	Epoxy 环氧树脂
Lens Color 胶体颜色	Yellow Diffused 黄色雾面
LED Diec 芯片	GaP
Emitting Colors 发光颜色	Yellow 黄光

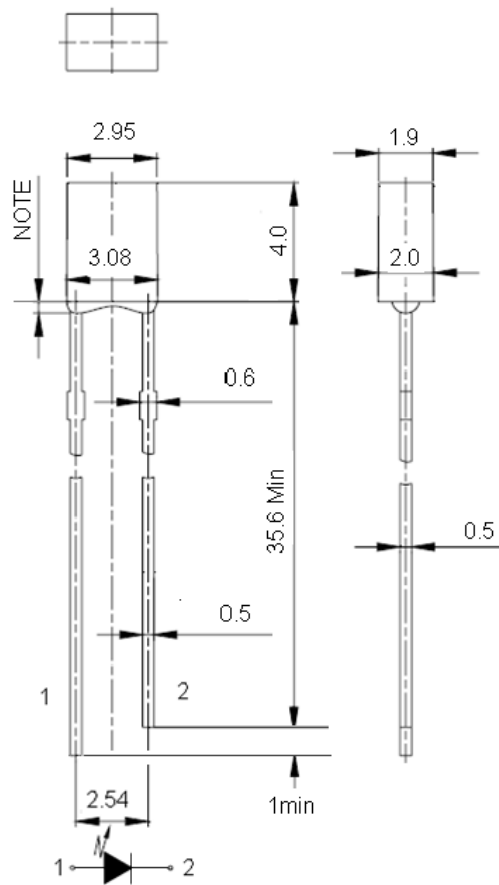

单位 (Units)	图面未注差 (Unless otherwise noted)	胶体外观公差 (Encapsulation tolerance)	胶体伸出尺寸 (NOTE) (Dimensions of protruded resin flange)
mm	±0.1	±0.25	Max 1.0



❖ Absolute Maximum Ratings 最大额定值 (Ta=25℃)

Item 项目	Symbol 符号	Value 数值	Unit 单位
Power Dissipation 消耗功率	P _D	75	mW
DC Forward Current 直流正向驱动电流	I _F	30	mA
Pulsed Forward Current 脉冲正向驱动电流	I _{FP}	100*	mA
Reverse Voltage 反向电压	V _R	5	V
Operating Temperature 工作温度	T _{opr}	-30 ~ +80▲	℃
Storage Temperature 储存温度	T _{stg}	-40 ~ +100	℃
Soldering Temperature 焊接温度	T _{sol}	260for5sec	℃

Notes:

- ❖ * Duty 1/10, Pulse Width 0.1ms
占空比 1/10, 脉宽 0.1ms
- ❖ ▲ Please refer to the Curve of Forward Current vs. Ambient Temperature.
请参考最大驱动电流与环境温度曲线图

❖ Electrical-Optical Characteristics 光电特性参数 (Ta=25℃)

Parameter 参数	Symbol 符号	Value 数值			Unit 单位	Test condition 测试条件
		Min. 最小值	Typ. 典型值	Max. 最大值		
Forward Voltage 正向电压	V _f	1.8	---	2.6	V	If=10mA
Luminous intensity 发光强度	I _v	1	---	9	mcd	If=10mA
Wavelength 主波长	λ _d	585	---	595	nm	If=10mA
Reverse Current 反向电流	I _r	---	---	10	μA	V _r =5V
Viewing angle 发光角度	2θ _{1/2}	---	175	---	Deg	If=10mA

Notes:

- ❖ Luminous intensity (mcd) ±10%, Forward Voltage(VF) ±0.1V, Wavelength(x,y) ±1nm±0.01
发光强度测试公差为±10%，正向电压测试公差为±0.1V，波长测试公差为±1nm。色坐标 (x,y)
测试公差为±0.01
- ❖ IS standard test
以IS 标准机测试为标准



❖ Electrical characteristic graph 电气特性曲线

Fig.1 If Vs Vf (Ta=25°C)

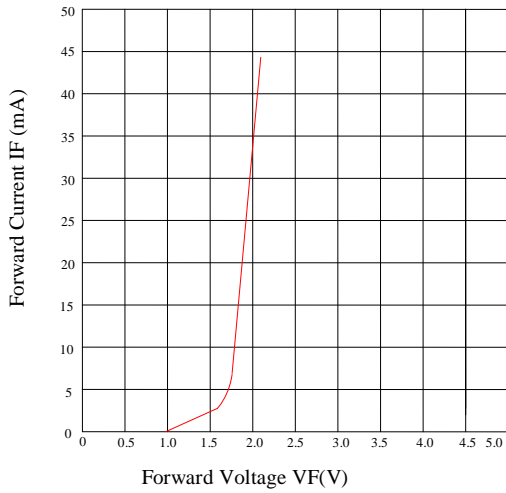

Fig.2 Wavelength Characteristics (Ta=25°C)

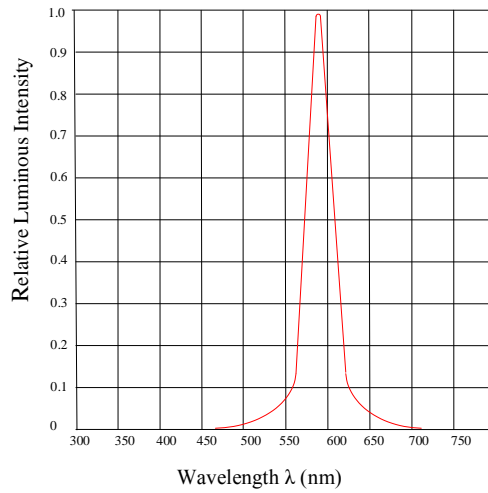

Fig.3 If Vs Ta

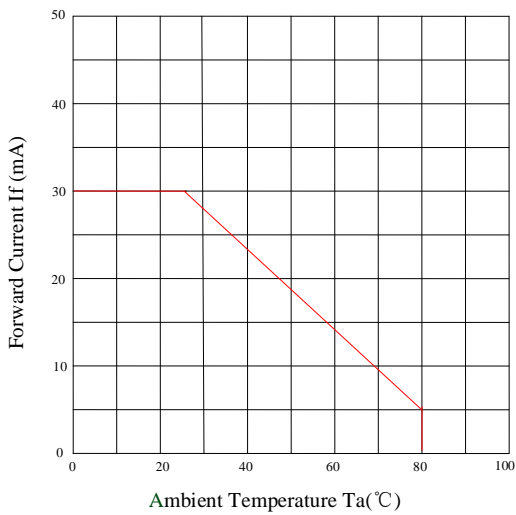

Fig.4 Iv Vs If (Ta=25°C)

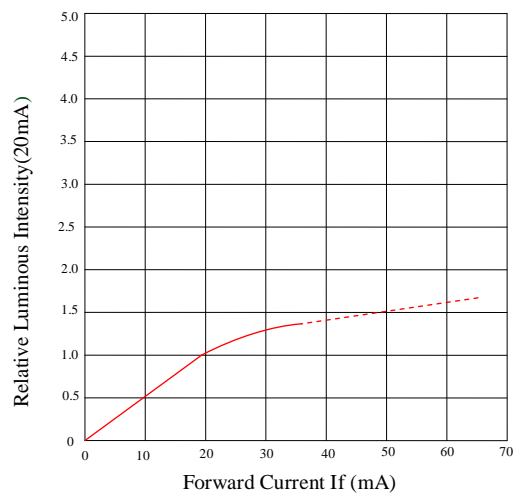

Fig.5 Iv Vs Ta

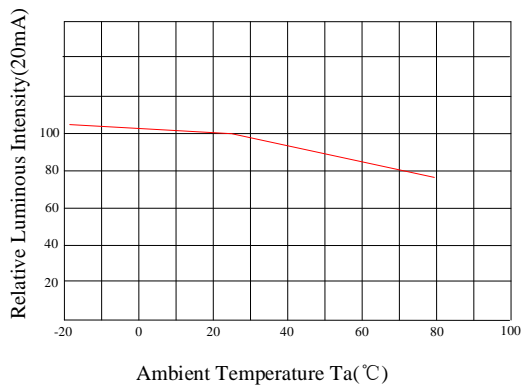
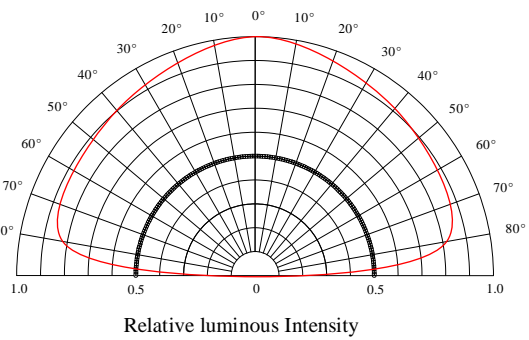

Fig.6 View Angle (Ta=25°C)





LED Usage and Handling Instructions

Dear valued clients:

尊敬的客户:

Thank you for choose our LED products. LEDs are delicate semiconductor product that should be handle according to the below instructions.

非常感谢您选用弘亮光电LED产品，LED使用应遵循以下说明：

A. Storage 仓储:

1. LEDs should be stored in a sealed container with ambient temperature of $23 \pm 5^{\circ}\text{C}$ and relative humidity of 40 ~ 70 % with silica gel desiccants to ensure their shelf life will not exceed 1 year.

直插式LED 应储存在室温（ $23 \pm 5^{\circ}\text{C}$ ）相对湿度40 ~ 70 % 的密闭有干燥剂的包装袋内，其储存期限应不超过1年。

2. LEDs should be used within three months of being taken out of their original packages to avoid lead frame rusting.

直插式LED 拆开原包装后，应该在3个月内进行焊接，以免引脚氧化。

B. Cleaning 清洗:

1. Do not use any unidentified chemical to clean LEDs, it could damage or crack the LED epoxy surface. If necessary, soak LED in alcohol for a time not exceeding one minute in normal temperature.

不要使用任何化学溶剂清洗LED胶体，以免腐蚀损坏LED 胶体表面。如果必须清洗，请使用酒精类溶剂浸泡LED，但不能在常温下超过1分钟。

C. Lead Frames Shaping & Trimming 成型加工（弯脚和剪脚）

1. The shaping should be done underneath the wedge point. No pressure should be exerted to the epoxy shell of the LED during shaping.

灯脚成型应在支架上靶切点以下进行，且不能有力作用在LED胶体上。

2. Bending of the leads should be bent at a point at least 3 mm from the base of the Epoxy bulb and do not use the base of the lead as a fulcrum during lead forming

弯脚时，至少保证引脚弯脚点距离胶体3mm以上，且不能将引脚作为着力支点。

3. Shaping of the leads should be done before soldering.

引脚成型应在引脚焊接前完成。

4. Lead trimming should only be done at room temperature.

剪脚只能在室温下进行。



D. ESD (Electrostatic Discharge) 静电防护

1. LED is very sensitive to ESD; please make sure during the whole usage and installation process, that no ESD exist to affect the LED. Excessive ESD could damage the LED chip and result in performance degradation.

LED是一个静电敏感元器件，请确认整个使用和装配过程不会产生静电影响LED，过大的静电可能会导致LED芯片击穿烧毁。

2. LED can also be damaged by electrical surge, please make sure any driving electrical circuits are equipped with surge protection.

浪涌脉冲也可能导致LED损坏，请确认驱动LED电路和设备是否有超载保护。

3. During the installation process, please make sure all the equipment and personnel are grounded properly. Make use ESD protection equipment such as anti-static gloves, anti-static wrist bands, anti-static mats, anti-static clothes, anti-static shoes, and anti-static containers.

加工装配期间，请确认所有的设备和人员是否有有效的接地连接，并有静电防护措施，比如人员佩戴防静电手套、防静电手环、穿戴防静电服，防静电鞋，以及使用防静电转料箱等...

4. When LED come into contact with low electrical resistance metallic surfaces, the ESD could damage the LED due to sudden discharge of ESD. Please make sure all surfaces that will be in contact with LED are covered with anti-static mats (Surface electrical resistance of $10^6 \sim 10^8 \Omega/\text{sq}$). LED should be placed in anti-static containers and anti-static bags.

当LED接触低阻抗材料表面时，突然的静电释放可能会造成LED的损坏，请确认所有可以接触到LED的工作台表面有铺设防静电皮垫（表面阻抗应在 $10^6 \sim 10^8 \Omega/\text{平方米}$ ），LED应存放在防静电箱和防静电袋内。

5. All soldering irons and Test equipments should be grounded and production environment should make use of ion-blowers.

所有焊接烙铁和测试设备都应该有良好接地连接。加工LED的工位应使用离子风扇去除静电。



E. Directions for Use. (电路设计说明)

- 1. When designing a circuit, the current through each LED must not exceed the Absolute Maximum Rating. (refer to page 3)

当设计一个电路驱动LED时，必须遵循其驱动每一个LED的条件必须低于规格书中注明最大的额定值。(参考第三页)

- 2. Operating at a constant current per LED is recommended. In case of operating at a constant voltage, circuit B is recommended. If the LEDs are operated with constant voltage using circuit A, the current through the LEDs may vary due to the variation in Forward Voltage characteristics of the LEDs.

推荐使用恒流电路驱动每一个LED，如果万一需要使用恒压电路并联驱动多个LED，推荐选择线路B，由于LED顺向电压变化特性的原因，如果使用线路A驱动，可能导致LED亮度不一致。

- 1) Serial connection (串联电路)

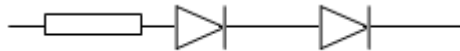

- 2) Parallel connection (并联电路)

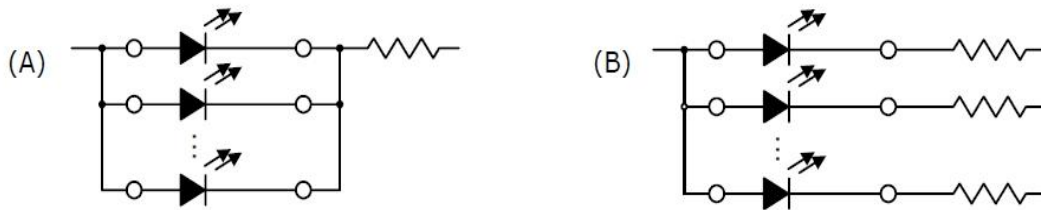

- 3. Sudden surge could damage the LED interior connections. Please design circuit with care so no sudden voltage surge or current surge will show when turning the circuit on or off.

超负载的突波（浪涌）可能会造成LED内部线路的损坏，所以设计驱动电路时请注意防范电路开关时突波电压和电流的产生。

- 4. When color or brightness uniformity is required while using multiple LEDs, the LED driver condition is critical. Our company guarantees the uniformity of the LEDs from the same bin when the driver current with same sorting current.

当同时使用多颗LED时，LED发光颜色和亮度的均匀性是很重要的。我们公司可以保证当使用的驱动电流与我司分BIN测试电流一致时，同一BIN区的LED发光颜色和亮度一致。



F. Soldering 焊接

1. When soldering, the soldering point needs to be at least 3mm away from the epoxy edge. After soldering, allow at least 3 minutes for LEDs to cool back to normal temperature. Do not apply any pressure to the epoxy encapsulation or the lead frame during the soldering process.

焊接时，应保证焊接点距离LED胶体边缘至少3 mm以上。焊接后，且至少需要3分钟时间冷却到常温，且整个过程中不能有任何力作用到LED胶体上。
2. When reflow soldering or wave soldering, please solder once for less than 10 seconds at a maximum temperature of 260°C. During the soldering process, if the temperature or timing is not controlled within limits, it would cause the epoxy to deform or cause the die or wires within the LED to be damaged.

波峰焊或回流焊时，最高温度不能超过260°C，时间不能超过10秒，若焊接条件超出极限，可能会导致LED损坏。
3. When using soldering iron, please solder once for less than 5 seconds at a maximum temperature of 340°C. When soldering a row of LED on a PCB, please do not solder both leads of a LED in sequence. (Solder all the positive lead first, then all the negative leads)

烙铁焊接时，最高温度不能超过340°C，时间不能超过5S，当焊接一排LED时，应先焊接所有LED的正极，再焊接LED的负极，不要同时焊接1个LED的正负两极。
4. Do not dip the epoxy encapsulation part of LED into any soldering paste liquid.

焊接时，应不要让任何助焊溶剂滴落在LED胶体上。
5. After soldering, do not adjust the location of the LED anymore.

焊接后，应不再做二次焊接移动LED位置。
6. In order to avoid damage on the lens during soldering and clinching the leads, It is not recommended to solder the LEDs directly on customer PCB without any gap between the lens and the board. If it is unavoidable ,customer is advised to check whether such soldering will not cause wire breakage or lens damage

为了不损坏LED胶体在焊接和铆接灯脚期间，不推荐客户直接将LED贴板焊接在PCB上（LED胶体与PCB间无任何缝隙），如果必须这样焊接，请客户确认这样加工是否会导致LED金线断裂或者胶体损坏。
7. When it is necessary to clamp the LEDs to prevent soldering failure, it is important to minimize the mechanical stress on the LEDs.

当必须固定LED引脚才可以进行焊接时，应尽可能避免大的机械外力作用到LED胶体上，这是很重要的。



G. Recommend Soldering Cure Profile For Pb Free

推荐的无铅波峰焊接温度曲线

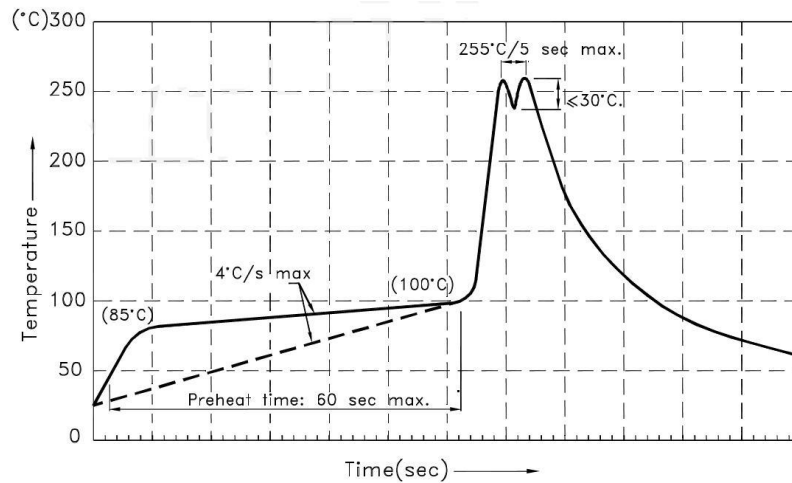

H. Installation 装配

1. During the installation process, do not apply any pressure to the LED lens.
装配期间，不要有任何外力作用到LED胶体上。
2. Please make sure the installation part dimension matches the dimension of the LED. Including to tolerance.
装配时，请确认装配件的尺寸是否匹配LED尺寸公差。
3. The diameter of the dip holes on PCB should be 0.8~1.0mm. The distance between the centers of the two dip holes should be within $\pm 0.02\text{mm}$ of the LED lead pitch (standard LED lead pitch is 2.54 mm) . For special LED lead pitch specifications, the distance should be adjusted accordingly.
PCB上的焊盘孔径应在0.8~1.0mm之间，两个焊孔间距应与LED PIN 间距一致或尺寸差异控制在 $\pm 0.02\text{mm}$ 以内（标准LED的PIN间距为2.54mm），对于特殊PIN间距的LED，则PCB焊孔间距应随之调整。



I. Eye Safety 人体安全

1. Please comply with government electrical safety code while using the LEDs.
请使用符合政府规定的电子安全等级使用LED。
2. Do not look directly into a lit LED; it could feel uncomfortable the eyes.
不要直接正面对视发光的LED，可能会使我们的眼睛感到不舒服。
3. Do not look directly into powered UV LEDs; it could damage the eyes after only a few seconds. (UV LEDs are mainly used in currency validating machines and the Sterilize instruments)
不要直接目视紫外LED，可能会在几秒钟内损伤我们的眼睛。（紫外LED主要用于验钞设备和医疗消毒器械）
4. In 2006, the International Electrical Commission (IEC) published IEC 62471:2006 Photobiological safety of lamps and lamp systems, which added LEDs in its scope. On the other hand, the IEC60825-1:2007 laser safety standard removed LEDs from its scope. However, please be advised that some countries and regions have adopted standards based on the IEC laser safety standard IEC60852-1:20112001, which still include LEDs in its scope. Most of our LEDs can be classified as belonging into either the Exempt Group or Risk Group1.High-power LEDs, that emit light containing blue wavelengths, may be classified as Risk Group2.
在2006年，IEC建立光生物安全标准 IEC62471:2006,并将LED纳入其范围。另一方面，IEC又从激光安全标准IEC60825-1:2007将LED移除。可是一些国家和地区采用的标准是激光安全标准 IEC60852-1:20112001,这个标准包含了LED。我司的大多数LED产品可以归类到豁免 或者1级风险目录中，高功率能够发射蓝光波段的光的LED产品可能应归类到2级风险目录中。
5. Viewing a flashing light may cause eye discomfort. When incorporating the LED into your product, please be careful to avoid adverse effects on the human body caused by lighting stimulation.
观察一个闪烁光会造成眼睛不适，当您的产品使用到LED时，请注意避免光对人体刺激造成的不良影响。

**J. Test Items and Results of Reliability 可靠性测试**

Test Item	Test Conditions	Duration/ Cycle	Number of Damage	Reference
Temperature Cycle	-40°C 30min ↑↓ 1 min 100°C 30min	168 cycles	0/20	JEITA ED-4701 300 303
High Temperature Storage	T _a =85°C	1000 hrs	0/20	EIAJED-4701 200 201
High Humidity Heat Life Test	T _a =85°C RH=85% I _F @Max Rating Current	1000 hrs	0/20	EIAJED-4701 200 201
Humidity Heat Storage	T _a =85°C RH=85%	1000 hrs	0/20	EIAJED-4701 100 103
Life Test	T _a =25°C I _F =20mA	1000 hrs	0/20	EIAJED-4701
Low Temperature Life Test	T _a =-35°C I _F =20mA	1000 hrs	0/20	EIAJED-4701
High Temperature Life Test	T _a =85°C I _F @Max Rating Current	1000 hrs	0/20	EIAJED-4701
*Criteria for Judging				
Item	Symbol	Condition	Criteria for Judgment of Pass	
			Min	Max
Forward Voltage	V _F	I _F =20mA	-	USL* ¹ ×1.1
Reverse Current	I _R	V _R = -5V	-	10μA
Luminous Intensity	I _v	I _F =20mA	LSL* ² ×0.7	-

Notes:

- ◆ USL*¹: Upper Specification Level
- ◆ LSL*²: Lower Specification Level