



Table of Contents 目录

❖ Table of contents and Version change list	
目录和规格书版本变更履历	02
❖ Outline Dimensions	
外观尺寸图纸	03
❖ Maximum Rating	
最大额定电性参数	04
❖ Electronic-optical Characteristics	
LED 光电参数数据表	04
❖ Range of Bins	
LED 分光数据表	05
❖ Electronic-optical Graph	
光电参数关系图表	06
❖ Package specification	
包装规格	07
❖ LED Usage and Handling Instructions	
LED 使用说明	09
❖ Reliability test	
可靠性测试标准	17



❖ Outline Dimensions 外观尺寸

Item 项目	Materials 材质
Resin(Mold)胶体	Epoxy 环氧树脂
Lens Color 胶体颜色	Yellow 黄色
LED Diec 芯片	InGaN
Emitting Colors 发光颜色	White 白光

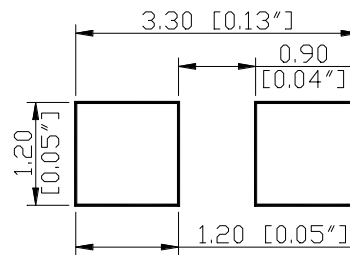
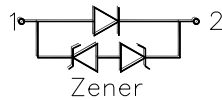
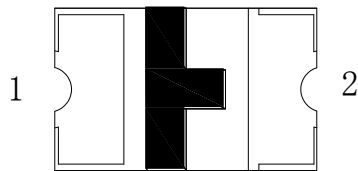
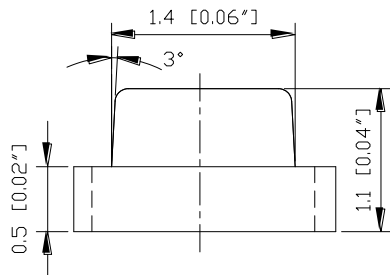
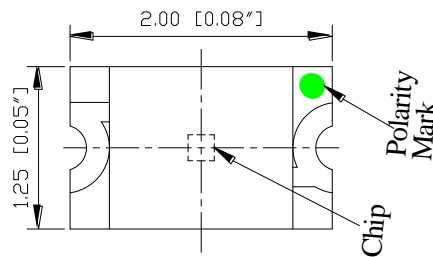

Notes:

- ❖ All dimensions are in millimeters(inch)
图中所有尺寸单位为 mm (英寸)
- ❖ Tolerance is +/-0.1mm(0.004 ") unless otherwise noted
图中所有未注明的尺寸公差都为 +/-0.1mm 或者(0.004")
- ❖ Specifications are subject to changes for improvement without advance notice Proprietary data, Drawings, Company confidential all rights reserved
规格和图纸版本升级不再做另行通知，所有的版权归弘亮光电公司所有。



❖ Absolute Maximum Ratings 最大额定值 (Ta=25℃)

Item 项目	Symbol 符号	Value 数值	Unit 单位
Power Dissipation 消耗功率	P _D	100	mW
DC Forward Current 直流正向驱动电流	I _F	30	mA
Pulsed Forward Current 脉冲正向驱动电流	I _{FP}	100*	mA
Reverse Voltage 反向电压	V _R	5	V
Operating Temperature 工作温度	T _{opr}	-30 ~ +80▲	℃
Storage Temperature 储存温度	T _{stg}	-40 ~ +100	℃
Soldering Temperature 焊接温度	T _{sol}	260for5sec	℃

Notes:

- ❖ * Duty 1/10, Pulse Width 0.1ms
占空比 1/10, 脉宽 0.1ms
- ❖ ▲ Please refer to the Curve of Forward Current vs. Ambient Temperature.
请参考最大驱动电流与环境温度曲线图

❖ Electrical-Optical Characteristics 光电特性参数 (Ta=25℃)

Parameter 参数	Symbol 符号	Value 数值			Unit 单位	Test condition 测试条件
		Min. 最小值	Typ. 典型值	Max. 最大值		
Forward Voltage 正向电压	V _f	2.5	---	3.4	V	I _f =5mA
Luminous intensity 发光强度	I _v	63	---	200	mcd	I _f =5mA
Chromatic coordinates 色坐标	X	---	0.328	---		I _f =5mA
	Y	---	0.352	---		
Reverse Current 反向电流	I _r	---	---	10	μA	V _r =5V
Viewing angle 发光角度	2θ _{1/2}	---	140	---	Deg	I _f =5mA

Notes:

- ❖ Luminous intensity (mcd) ±10%, Forward Voltage(VF) ±0.1V, Wavelength(x,y) ±1nm/±0.01
发光强度测试公差为±10%，正向电压测试公差为±0.1V，波长测试公差为±1nm。色坐标 (x,y)
测试公差为±0.01
- ❖ IS standard test
以IS 标准机测试为标准



❖ Range of bins (BIN 区规格) @5mA

Item 项目	BIN Code Data BIN 代码数据					
	e	f	g			
VF(V)	2.5-2.8	2.8-3.1	3.1-3.4			
BIN	H	J	K	L	M	
Iv(mcd)	63-80	80-100	100-120	120-160	160-200	

❖ Color coordinate Comparison 色区坐标 @5mA

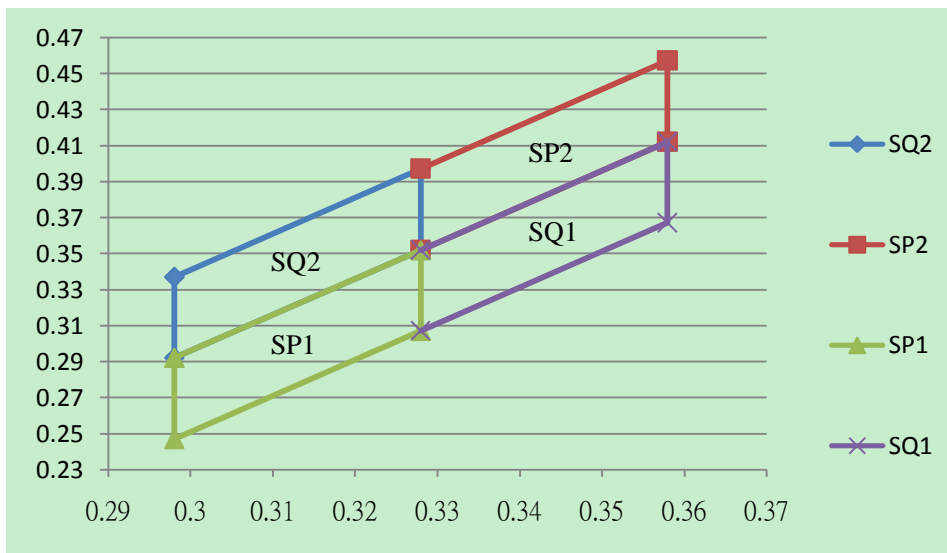

SQ2	X	0.298	0.328	0.328	0.298
	Y	0.337	0.397	0.352	0.292
SP2	X	0.328	0.358	0.358	0.328
	Y	0.397	0.457	0.412	0.352
SP1	X	0.298	0.328	0.328	0.298
	Y	0.292	0.352	0.307	0.247
SQ1	X	0.328	0.358	0.358	0.328
	Y	0.352	0.412	0.367	0.307



❖ Electrical characteristic graph 电气特性曲线

Fig.1 If Vs Vf (Ta=25°C)

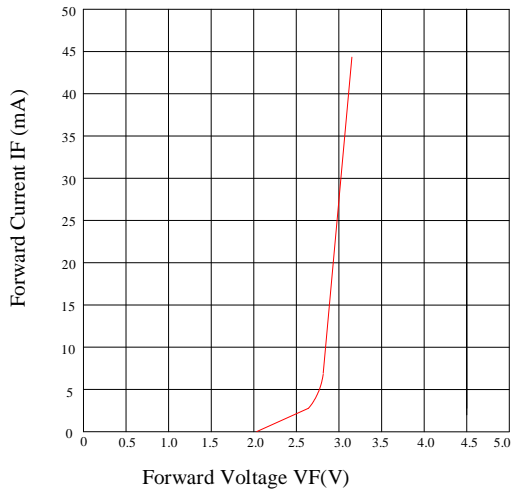

Fig.2 Wavelength Characteristics (Ta=25°C)

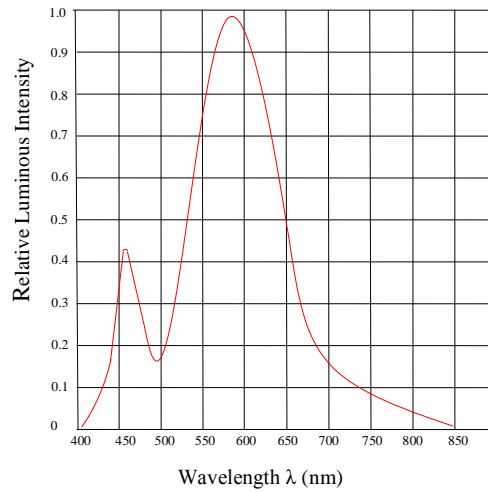

Fig.3 If Vs Ta

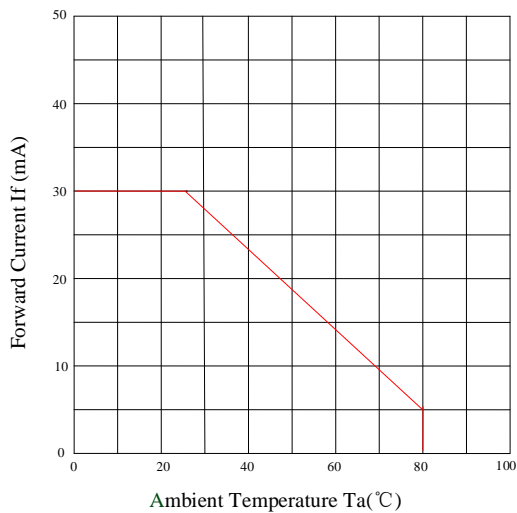

Fig.4 Iv Vs If (Ta=25°C)

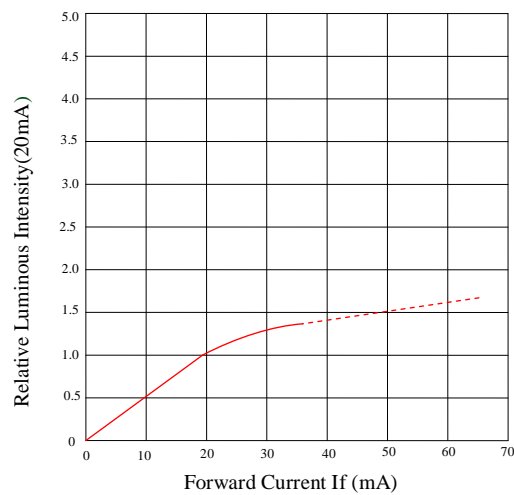

Fig.5 Iv Vs Ta

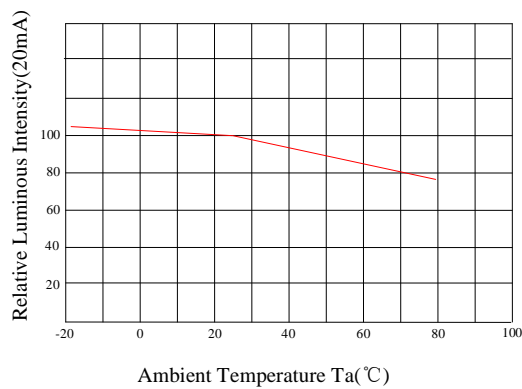
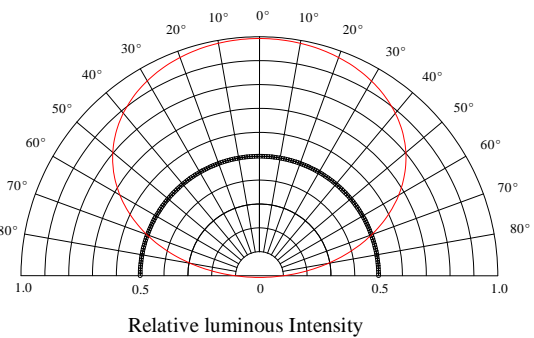

Fig.6 View Angle (Ta=25°C)





❖ Package Tape Specifications 包装带规格

❖ Feeding Direction 送料方向

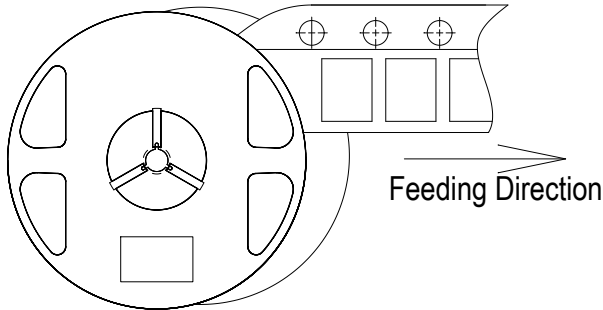

❖ Dimensions of Reel 卷盘尺寸(Unit: mm)

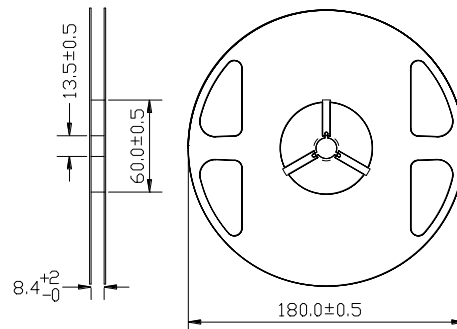

❖ Dimensions of Tape 料带尺寸(Unit: mm)

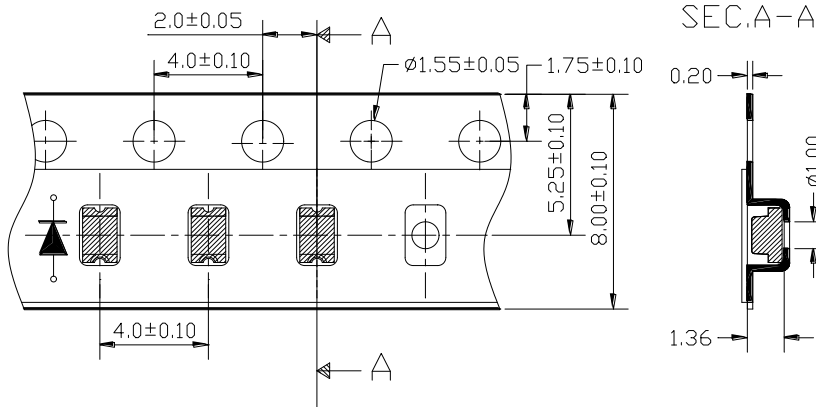

❖ Arrangement of Tape 料带分布(Unit: mm)

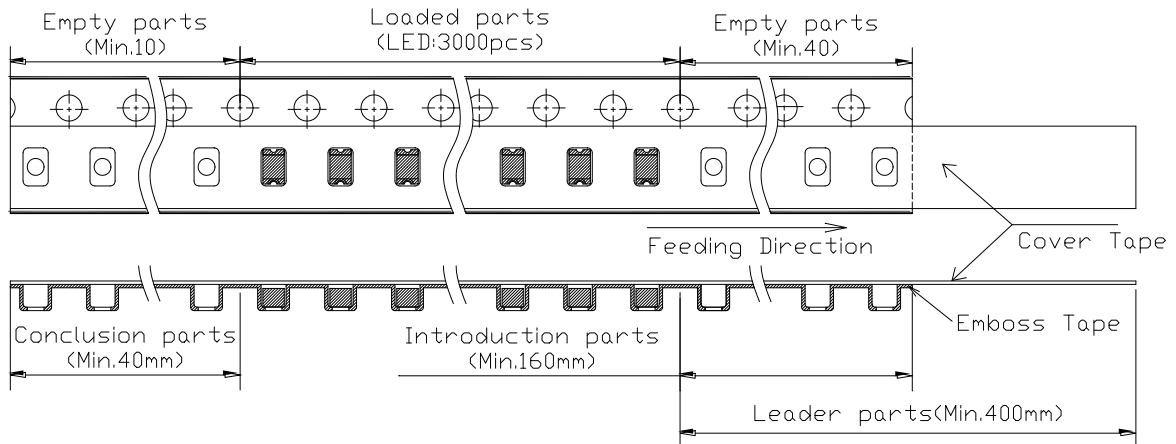

Notes:

- ❖ Empty component pockets are sealed with top cover tape;
载带开头一些是空的为包装产品。
- ❖ The maximum number of missing lamps is two, 3000pcs/Reel.
每卷 3000pcs 产品，数量误差为 2pcs。
- ❖ The cathode is oriented towards the tape sprocket hole in accordance with ANSI/EIA RS-481 specifications;
按照 NSI/EIA RS-481 要求产品负极朝向载带有孔的那一边。



❖ Packaging specifications 包装规格

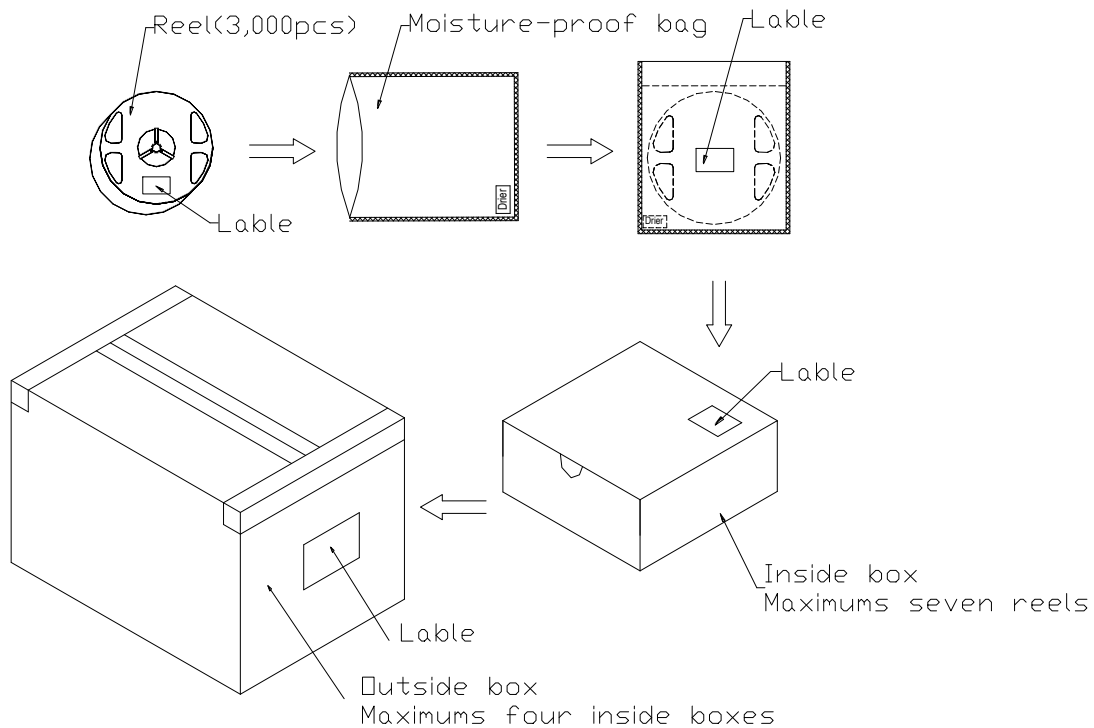

Notes:

Reeled products (numbers of products are 3,000 pcs) packed in a seal off moisture-proof bag along with a desiccant one by one, Seven moisture-proof bag of maximums (total maximum number of products are 21,000 pcs) packed in an inside box (size: about 283mm x about 194mm x about 102mm) and four inside boxes of maximums are put in the outside box (size: about 410mm x about 254mm x about 229mm) Together with buffer material, and it is packed. (Part No., Lot No., quantity should appear on the label on the moisture-proof bag, part No. And quantity should appear on the label on the cardboard box.) The number of the loading steps of outside box (cardboard box) has it to three steps.

每卷包装 3000pcs 产品，真空密封包装到 1 个防潮袋内。每 7 个防潮袋放入一个内箱（内箱尺寸约 283mm x 194mm x 102mm），即每个内箱装 21000pcs 产品。每 4 个内箱装一个外箱（外箱尺寸约 410mm x 254mm x 229mm），然后用填充物塞满箱子。在外箱和内箱以及防潮袋的标签上都会标注产品信息，比如产品型号，批号，数量等



LED Usage and Handling Instructions

Dear valued clients:

尊敬的客户:

Thank you for choose our LED products. LEDs are delicate semiconductor product that should be handle according to the below instructions.

非常感谢您选用弘亮光电 LED 产品，LED 使用应遵循以下说明：

A. Storage 仓储:

1. SMD LEDs should be stored in a sealed container at less than 30 °C and 90 % (RH) with silica gel desiccants to ensure their shelf life will not exceed 1 year.

贴片式 LED 应储存在室温低于30 °C相对湿度低于90 %的密闭有干燥剂的包装袋内，其储存期限应不超过1年。

2. SMD LED is a humidity sensitive product it complies with JEDEC MSL 3 or equivalent see IPC/JEDEC STD-020 for moisture-sensitivity details.

贴片式LED是湿敏组件，湿敏等级JEDEC MSL 3 级相当与，它的使用储存应遵循IPC/JEDEC STD-020的标准。

2.1 Shelf life shee

Conditions 条件		Temperature 温度	Humidity 湿度	Time 时间
Storage 储存	Before opening bag 打开袋子前	≤30 °C	≤90%RH	Within 1 year from Delivery Date 从交付之日起 1 年
	After opening bag 打开袋子后	≤30 °C	≤60%RH	≤168Hrs 168 小时内
Baking 除湿烘烤		65+/-5 °C	≤10%	≥48Hrs 48 小时以上



3. Absorbed moisture in LED packages can vaporize and expand during soldering, which can cause interface delamination and result in optical performance degradation. Products are packed in moisture-proof bags to minimize moisture absorption during transportation and storage. Included silica gel desiccants change from blue to red if moisture had penetrated bags.
贴片式LED吸湿后，当经过高温焊接时，会造成硅胶与支架分层，而引起LED光电性能下降，甚至损坏。当防潮袋中的干燥剂或湿度卡由蓝色变为红色说明在运输和储存过程中湿气已经穿透袋子。
4. After opening the moisture-proof bag, the LEDs should go through the soldering process within the range of the conditions stated above. Unused remaining LEDs should be stored with silica gel desiccants in a hermetically sealed container, preferably the original moisture-proof bags for storage.
打开防潮袋后，贴片LED应在上表规定的时间内进行焊接，剩下的尾数应保存在原来的防潮袋中，并放入干燥剂密封包装储存。
5. After the “Period after opening” storage time has been exceeded or silica gel desiccants are no longer blue, the products should be baked. Baking should only be done once.
打开防潮袋后，再次密封包装储存时间超过规定时间 或者 干燥剂或湿度卡不是蓝色的，则需要对LED进行除湿烘烤，方可进行高温焊接，除湿条件参考2.1表。
6. Customer is advised to keep the LEDs in an airtight container when not in use. Exposure to a corrosive environment. May cause the plated metal parts of the product to tarnish, which could adversely affect soldering and optical characteristics. It is also recommended to return the LEDs to the original moisture proof bags and reseal.
建议客户在不使用LED时，将LED储存在一个密封的容器中，如果将LED暴露在有腐蚀性的环境中，可能会导致LED焊脚镀层变暗，导致LED可焊性和电气性能下降，推荐使用原本的防潮袋密封包装未使用的LED。
7. After assembly and during use, silver plating can be affected by the corrosive gases emitted by components and materials in close proximity of the LEDs within an end product, and the gases entering into the product from the external atmosphere. The above should be taken into consideration when designing. Resin materials, in particular, may contain substances which can affect silver plating, such as halogen.
当设计成品时应考虑LED的工作环境，不能让其暴露在有腐蚀性气体的环境中。比如含有卤素的松香或者一些可能腐蚀镀银层的元素。
8. Do not use sulfur-containing materials in end of products. Some materials such as seals and adhesives may contain sulfur. The extremely corroded or contaminated plating of LEDs might cause an open circuit. Silicone rubber is recommended as a material for seals.
成品中不要使用含硫的材料，比如一些密封圈和粘合剂中可能含有硫，硫对LED支架的镀银层



腐蚀是非常严重的，可能会导致电路开路，推荐使用硅胶类的密封圈

9. To prevent water condensation, please avoid large temperature and humidity fluctuations for the storage conditions.

注意预防水汽冷凝到LED表面，所以请最大限度的包装储存LED的温度和湿度不能有大的突变。

10. Do not store the LEDs in a dusty environment.

不要将LED 储存在一个落满灰尘的环境中。

11. Do not expose the LEDs to direct sunlight and/or an environment where the temperature is higher than normal room temperature.

不要将LED放置在阳光直接照射的环境下，那里的温度比室温要高很多。

B. Cleaning 清洗:

1. Do not use any unidentified chemical to clean LEDs, it could damage or crack the LED epoxy surface. If necessary, soak LED in isopropyl alcohol (IPA) for a time not exceeding one minute in normal temperature.

不要使用任何化学溶剂清洗LED胶体，以免腐蚀损坏LED 胶体表面。

如果必须清洗，请使用异丙醇浸泡LED，但不能在常温下超过1分钟。

2. Ultrasonic cleaning is not recommended since it may have adverse effects on the LEDs depending on the ultrasonic power and how LED is assembled. If ultrasonic cleaning must be used, the customer is advised to make sure the LEDs will not be damaged prior to cleaning.

不建议客户使用超声波对LED进行清洗和装配，这样可能会导致LED的可靠性下降，如果必须要使用超声波清洗或装配，请务必确认这样做是否会导致LED损坏。



C. ESD (Electrostatic Discharge) 静电防护

1. LED is very sensitive to ESD; please make sure during the whole usage and installation process, that no ESD exist to affect the LED. Excessive ESD could damage the LED chip and result in performance degradation.

LED是一个静电敏感元器件，请确认整个使用和装配过程不会产生静电影响LED，过大的静电可能会导致LED芯片击穿烧毁。

2. LED can also be damaged by electrical surge, please make sure any driving electrical circuits are equipped with surge protection.

浪涌脉冲也可能导致LED 损坏，请确认驱动LED电路和设备是否有超载保护。

3. During the installation process, please make sure all the equipment and personnel are grounded properly. Make use ESD protection equipment such as anti-static gloves, anti-static wrist bands, anti-static mats, anti-static clothes, anti-static shoes, and anti-static containers.

加工装配期间，请确认所有的设备和人员是否有有效的接地连接，并有静电防护措施，比如人员佩戴防静电手套、防静电手环、穿戴防静电服，防静电鞋，以及使用防静电料盒等...

4. When LED come into contact with low electrical resistance metallic surfaces, the ESD could damage the LED due to sudden discharge of ESD. Please make sure all surfaces that will be in contact with LED are covered with anti-static mats (Surface electrical resistance of $10^6 \sim 10^8 \Omega/\text{sq}$). LED should be placed in anti-static containers and anti-static bags.

当LED接触低阻抗材料表面时，突然的静电释放可能会造成LED的损坏，请确认所有可以接触到LED的工作台表面有铺设防静电皮垫（表面阻抗应在 $10^6 \sim 10^8 \Omega/\text{平方米}$ ），LED应存放在防静电箱和防静电袋内。

5. All soldering irons and Test equipments should be grounded and production environment should make use of ion-blowers.

所有焊接烙铁和测试设备都应该有良好接地连接。加工LED的工位应使用离子风扇去除静电。



D. Installation 装配

1. During the installation process, do not apply any pressure to the LED lens.
装配期间，不要有任何外力作用到LED胶体上。
2. During the installation process, do not touch to the LED lens.
装配期间，不要接触到LED胶体。
3. Please make sure the installation part dimension matches the dimension of the LED. Including to tolerance.
装配时，请确认装配件的尺寸是否匹配LED尺寸公差。

E. Handling Precautions 防范措施

1. As silicon is softer and flexible, its characteristic significantly reduces thermal stress, It is more susceptible to damage by external mechanical force; As a result ,special handing precautions need to be observed during assembly using silicone encapsulated LED products ,failure to comply might leads to damage and premature failure of the led;
硅胶是一种柔软的胶，它的特点是有良好的热传导和 低热应力，但机械保护力较差。所以在装配时需要特别注意，避免错误的手法导致LED失效。如下图示：

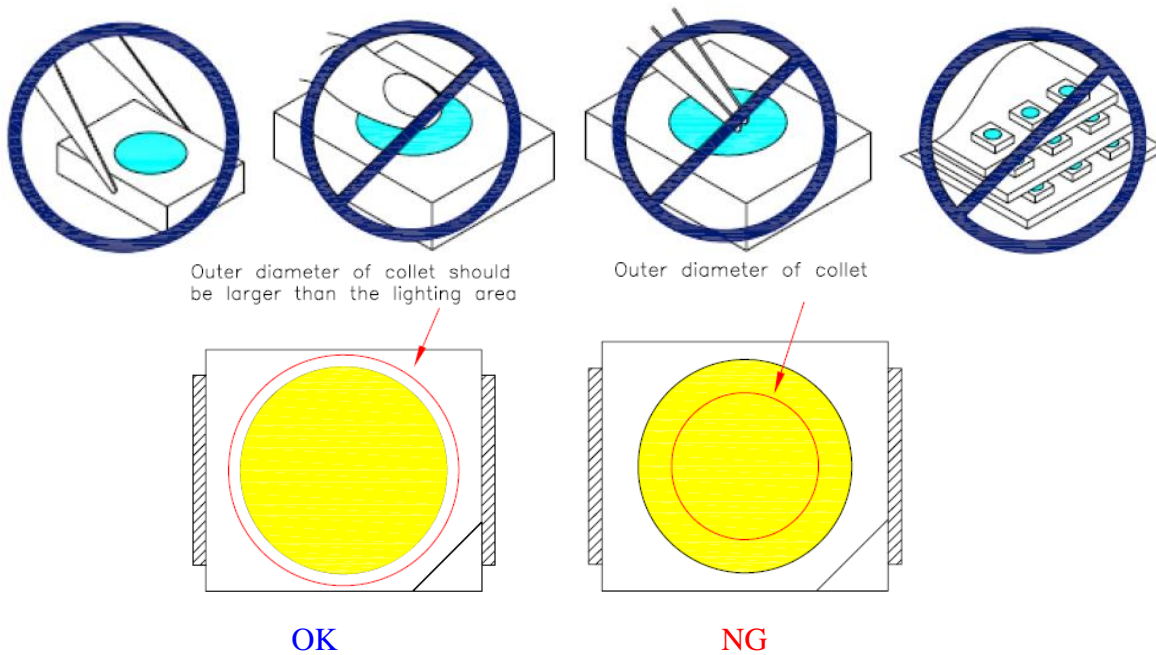



F. Directions for Use. (电路设计说明)

- 1. When designing a circuit, the current through each LED must not exceed the Absolute Maximum Rating. (refer to page 3)

当设计一个电路驱动LED时，必须遵循其驱动每一个LED的条件必须低于规格书中注明最大的额定值。(参考第三页)

- 2. Operating at a constant current per LED is recommended. In case of operating at a constant voltage, circuit B is recommended. If the LEDs are operated with constant voltage using circuit A, the current through the LEDs may vary due to the variation in Forward Voltage characteristics of the LEDs.

推荐使用恒流电路驱动每一个LED，如果万一需要使用恒压电路并联驱动多个LED，推荐选择线路B，由于LED顺向电压变化特性的原因，如果使用线路A驱动，可能导致LED亮度不一致。

- 1) Serial connection (串行电路)

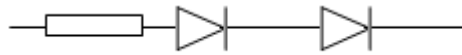

- 2) Parallel connection (并联电路)

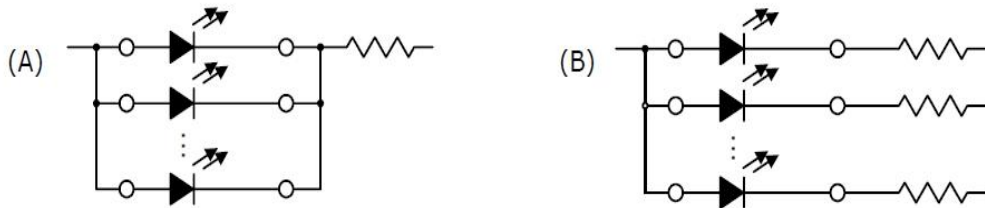

- 3. Sudden surge could damage the LED interior connections. Please design circuit with care so no sudden voltage surge or current surge will show when turning the circuit on or off.

超负载的突波（浪涌）可能会造成LED内部线路的损坏，所以设计驱动电路时请注意防范电路开关时突波电压和电流的产生。

- 4. When color or brightness uniformity is required while using multiple LEDs, the LED driver condition is critical. Our company guarantees the uniformity of the LEDs from the same bin when the driver current with same sorting current.

当同时使用多颗LED时，LED发光颜色和亮度的均匀性是很重要的。我们公司可以保证当使用的驱动电流与我司分BIN测试电流一致时，同一BIN区的LED发光颜色和亮度一致。



G. Soldering 焊接

1. Recommend soldering paste specifications:

推荐回流焊接规格如下图:

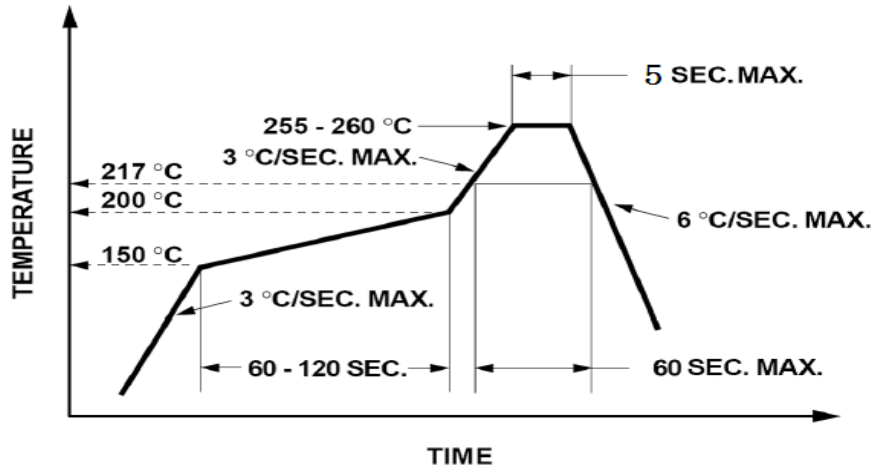

2. When reflow soldering or wave soldering, please solder once for less than 10 seconds at a maximum temperature of 260°C. During the soldering process, if the temperature or timing is not controlled within limits, it would cause the epoxy to deform or cause the die or wires within the LED to be damaged.

回流焊或波峰焊时，最高温度不能超过260°C，时间不能超过10秒，若焊接条件超出极限，可能会导致LED损坏。

3. Do not dip the epoxy encapsulation part of LED into any soldering paste liquid.

焊接时，应不要让任何助焊溶剂滴落在LED胶体上。

4. After soldering, do not adjust the location of the LED anymore.

焊接后，应不再做二次焊接移动LED位置。

5. Don't recommend using the soldering iron to solder.

不建议使用电烙铁进行焊接。

6. When reworking that should be completed within 3 seconds under 260°C. The iron tip must not come in contact with the copper foil. Twin-head type is preferred.

烙铁返修时，需要确保在260°C下3秒内完成，且烙铁头不能接触到LED。建议使用 双头烙铁。



H. Eye Safety 人体安全

1. Please comply with government electrical safety code while using the LEDs.
请使用符合政府规定的电子安全等级使用LED。
2. Do not look directly into a lit LED; it could feel uncomfortable the eyes.
不要直接正面对视发光的LED，可能会使我们的眼睛感到不舒服。
3. Do not look directly into powered UV LEDs; it could damage the eyes after only a few seconds. (UV LEDs are mainly used in currency validating machines and the Sterilize instruments)
不要直接目视紫外LED，可能会在几秒钟内损伤我们的眼睛。（紫外LED主要用于验钞设备和医疗消毒器械）
4. In 2006, the International Electrical Commission (IEC) published IEC 62471:2006 photobiological safety of lamps and lamp systems, which added LEDs in its scope. On the other hand, the IEC60825-1:2007 laser safety standard removed LEDs from its scope. However, please be advised that some countries and regions have adopted standards based on the IEC laser safety standard IEC60852-1:20112001, which still includes LEDs in its scope. Most of our LEDs can be calssified as belonging into either the Exempt Group or Risk Group1. High-power LEDs, that emit light containing blue wavelengths, may be classified as Risk Group2.
在2006年，IEC建立光生物安全标准 IEC62471:2006,并将LED纳入其范围。另一方面，IEC又从激光安全标准IEC60825-1:2007将LED移除。可是一些国家和地区采用的标准是激光安全标准 IEC60852-1:20112001,这个标准包含了LED。
我司的大多数LED产品可以归类到豁免 或者1级风险目录中，高功率能够发射蓝光波段的光的LED产品可能应归类到2级风险目录中。
5. Viewing a flashing light may cause eye discomfort. When incorporating the LED into your product, please be careful to avoid adverse effects on the human body caused by lighting stimulation.
观察一个闪烁光会造成眼睛不适，当您的产品使用到LED时，请注意避免光对人体刺激造成的不良影响。

**I. Test Items and Results of Reliability 可靠性测试**

Test Item	Test Conditions	Duration/ Cycle	Number of Damage	Reference
Temperature Cycle	-40°C 30min ↑↓ 1 min 100°C 30min	168 cycles	0/20	JEITA ED-4701 300 303
High Temperature Storage	T _a =85°C	1000 hrs	0/20	EIAJED-4701 200 201
High Humidity Heat Life Test	T _a =85°C RH=85% I _F @Max Rating Current	1000 hrs	0/20	EIAJED-4701 200 201
Humidity Heat Storage	T _a =85°C RH=85%	1000 hrs	0/20	EIAJED-4701 100 103
Life Test	T _a =25°C I _F =20mA	1000 hrs	0/20	EIAJED-4701
Low Temperature Life Test	T _a =-35°C I _F =20mA	1000 hrs	0/20	EIAJED-4701
High Temperature Life Test	T _a =85°C I _F @Max Rating Current	1000 hrs	0/20	EIAJED-4701
*Criteria for Judging				
Item	Symbol	Condition	Criteria for Judgment of Pass	
			Min	Max
Forward Voltage	V _F	I _F =20mA	-	USL* ¹ ×1.1
Reverse Current	I _R	V _R = -5V	-	10μA
Luminous Intensity	I _v	I _F =20mA	LSL* ² ×0.7	-

Notes:

- ❖ USL*¹: Upper Specification Level
- ❖ LSL*²: Lower Specification Level